

Shell Solar

Product Information Sheet

Shell ST40 Photovoltaic Solar Module

General

The Shell ST40 module is composed of a monolithic structure of series connected Copper Indium Diselenide (CIS) based solar cells.

The Shell ST40 can generate a peak power of 40 watt at 16.6 volt.

The Shell ST40 solar module has been designed for grid connected applications.

Qualifications and Certificates

The Shell ST40 solar module meets the following requirements:

- UL – Listing 1703



All Shell Solar modules are produced in EN-ISO 9001 certified factories.

Limited Warranties

- Peak Power for 10 years
- Product workmanship for 2 years

Shell ST40 Module

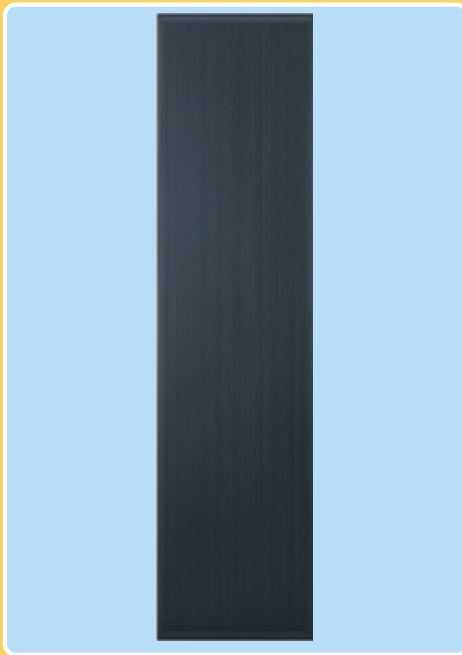

Junction Box

The junction box provides a high quality, dust protected and splash proof IP54-rated housing. The housing contains a rigid connection block with screw terminals and by-pass diodes providing "hot spot" protection for the solar cells.

ProCharger™-S Junction Box

Maximum conductor cross-section: 4 mm²

Type of protection: IP54

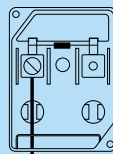

Benefits

- Exceptional performance under low light conditions, shade and high temperature tolerance that offers reliable power in adverse or changeable conditions.
- Class leading efficiency and stable output power delivering reliable high performance for many years.
- Highly transparent tempered glass delivering more power and ensuring high impact resistance and protection against hail, snow, ice and storms.
- Uniform appearance ideal for applications where aesthetics are an important factor.
- 10 years research and over 3 years commercial manufacturing experience has been applied to the development of our CIS thin-film range to ensure that our products have a long and reliable service life backed by a 10 year warranty.



**ELECTRICAL EQUIPMENT,
CHECK WITH YOUR INSTALLER**

Due to continuous research and product improvement the specifications in this Product Information Sheet are subject to change without notice. Specifications can vary slightly. For installation and operation instructions, see the applicable manuals. No rights can be derived from this Product Information Sheet and Shell Solar assumes no liability whatsoever connected to or resulting from the use of any information contained herein.



Shell ST40 Photovoltaic Solar Module

Mechanical Specifications Module

A torsion and corrosion-resistant anodised aluminium frame ensures dependable performance, even under harsh weather conditions. Pre-drilled mounting holes are provided for ease of installation.

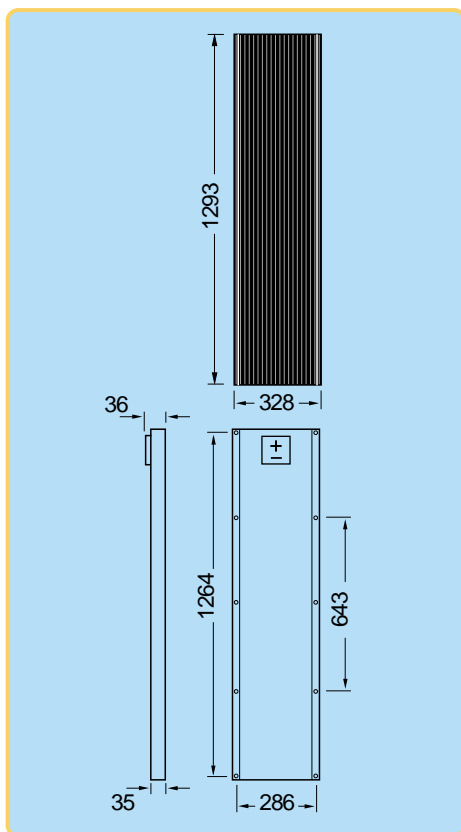

Outside dimensions (mm)	1293 x 328
Thickness (inc. junction box) (mm)	35
Thickness (exc. junction box) (mm)	35
Weight (kg)	7

For installation instructions, please refer to the **Installation Manual** which is available from Shell Solar.

Electrical Characteristics

Data at Standard Test Conditions (STC)

STC: irradiance level 1000W/m², spectrum AM 1.5 and cell temperature 25°C

Rated power	P_r	40W
Peak power	P_{mpp}	40W
Peak power voltage	V_{mpp}	16.6V
Open circuit voltage	V_{oc}	23.3V
Short circuit current	I_{sc}	2.68A
Minimum peak power	$P_{mpp \text{ min}}$	36W

The abbreviation 'mpp' stands for Maximum Power Point.

Typical data at Nominal Operating Cell Temperature (NOCT) conditions

NOCT: 800W/m² irradiance level, AM 1.5 spectrum, wind velocity 1m/s, T_{amb} 20°C

Temperature	T_{NOCT}	47°C
Mpp power	P_{mpp}	27.7W
Mpp voltage	V_{mpp}	14.7V
Open circuit voltage	V_{oc}	20.7V
Short circuit current	I_{sc}	2.2A

Typical data at low irradiance

The relative reduction of module efficiency at an irradiance of 200W/m² in relation to 1000W/m² both at 25°C cell temperature and AM 1.5 spectrum is 5%.

Temperature coefficients

αP_{mpp}	-0.6 %/°C
αV_{mpp}	-100 mV/°C
αI_{sc}	+0.35 mA/°C
αV_{oc}	-100 mV/°C

Maximum system voltage: 600 Vdc

Typical I/V Characteristics

The I/V graph below shows the typical performance of the solar module at various levels of irradiance.

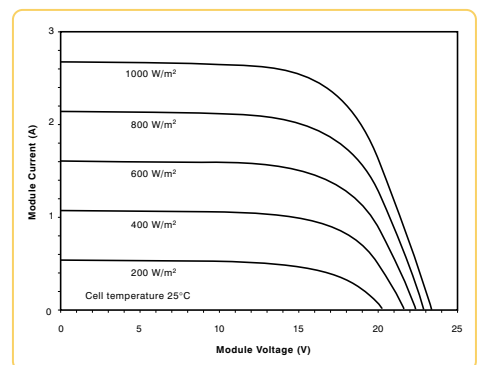

The I/V graph below shows the typical performance of the solar module at various cell temperatures.

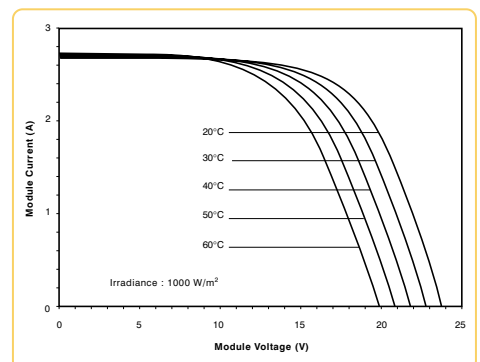

References in this Product Information Sheet to 'Shell Solar' are to companies and other organisational entities within the Royal Dutch/Shell Group of Companies that are engaged in the photovoltaic solar energy business. Shell Solar was set up in 1999 and has its principal office in Amsterdam, the Netherlands.

For further information on all Shell Solar products contact:

Shell Solar

Customer Service Centre
P.O.Box 849 5700 AV Helmond The Netherlands
Tel +31 492-508 751 Fax +31 492-508 700
E-mail solarinfo@si.shell.com
Web www.shellsolar.com

